

SERVICE ENTRANCE/ANCHOR BOLT LAYOUT

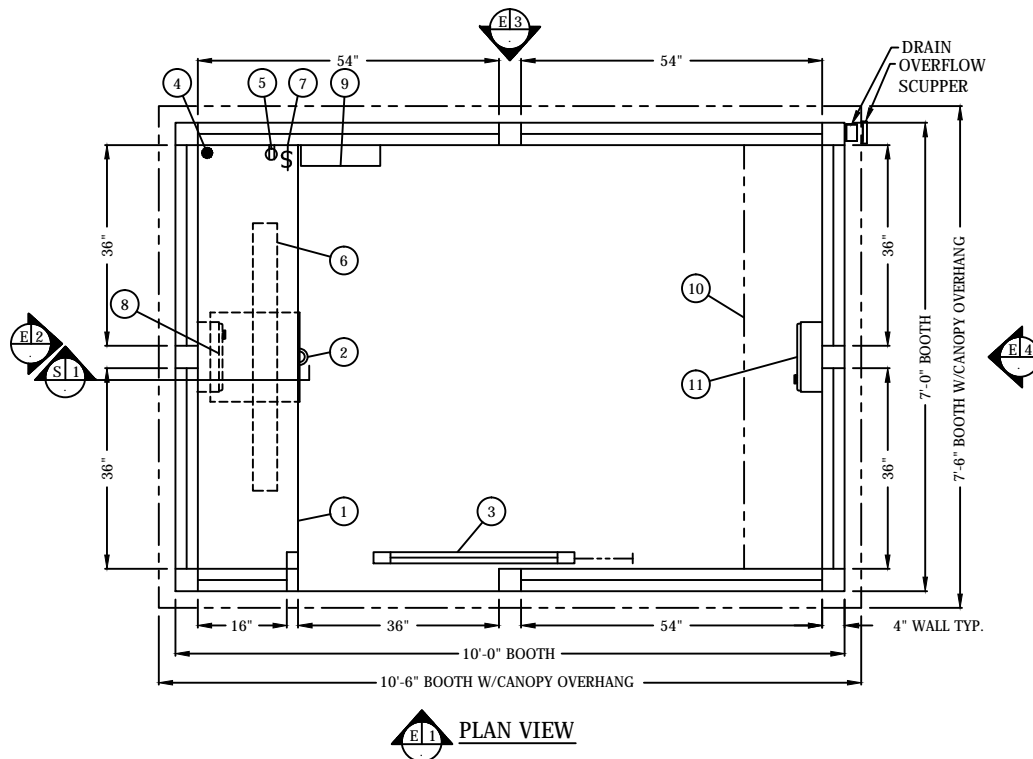

E1 PLAN VIEW

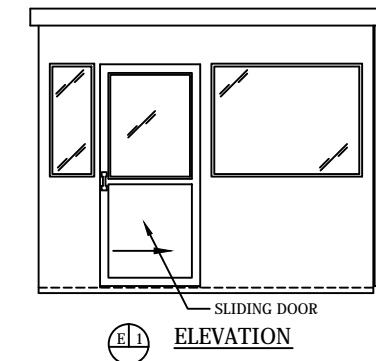

E1 ELEVATION

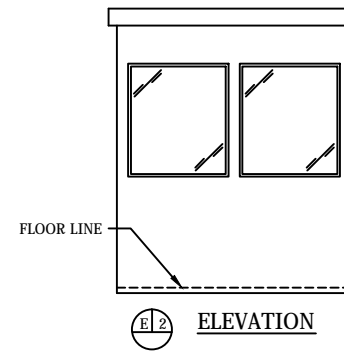

E2 ELEVATION

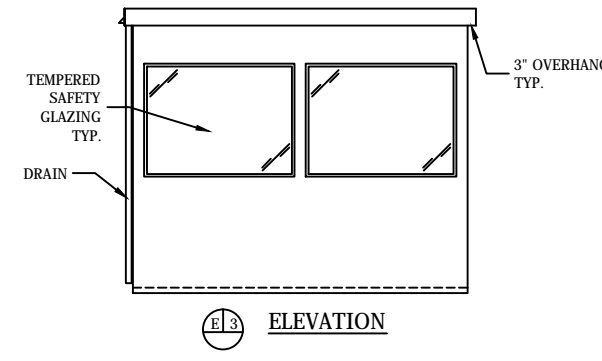

E3 ELEVATION

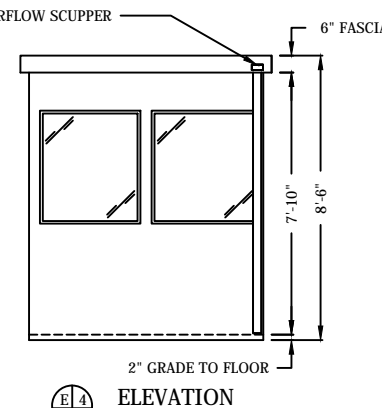

E4 ELEVATION

- SLOT IN FLOOR FOR ELECTRICAL SERVICE ENTRANCE TO C.B. PANEL.
- 2" X 2" X 1/4" (MIN) STEEL ANCHOR CLIP WITH A 3/4" ANCHOR BOLT HOLE, 4-REQ'D. ONE EACH CORNER. ANCHOR BUILDING AFTER FINAL LOCATION. ANCHOR BOLTS NOT INCLUDED.
- OUTER EDGE OF BUILDING.
- SUGGESTED MINIMUM FOUNDATION/SLAB.

GENERAL SITE INSTALLED ITEMS PROVIDED BY OTHERS

- PROVIDE 120V/240V, SINGLE PHASE, 3-WIRE SERVICE WITH GROUND.
- CONCRETE FOUNDATION/SLAB MINIMUM 6" DEEP, 3,000 PSI MINIMUM (28 DAY ACI 318). THE FOUNDATION/SLAB SHOULD BE A MINIMUM OF 24" WIDER THAN THE BUILDING FOOT PRINT DIMENSIONS. THIS IS TO PROVIDE A 12" CONCRETE BORDER ON EACH SIDE OF THE BUILDING.
- ADEQUATE SIZE DRILLED ANCHOR BOLTS. SUGGESTED SIZE: 3/8" X 4 1/2" POWER FASTENERS "POWER STUD" CATALOG #7332.

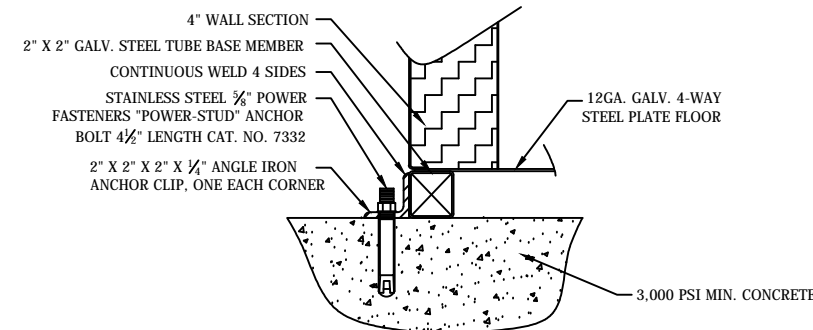

FIELD DRILLED ANCHOR BOLT DETAIL
NO SCALE

THIS DRAWING IS FOR REFERENCE PURPOSES ONLY. PAR-KUT BUILDINGS MUST BE SECURELY ANCHORED IN PLACE AND ELECTRICAL SYSTEM MUST BE PROPERLY GROUNDED. ADEQUATE SIZED ANCHOR BOLTS SHALL BE USED. THE SIZE AND DEPTH OF THE ANCHORS SHOULD BE OF SUFFICIENT DESIGN TO WITHSTAND THE HIGHEST RECORDED WIND SPEEDS/SEISMIC DESIGN CATEGORY IN THE AREA OF INSTALLATION. CONSULT A PROFESSIONAL ENGINEER FAMILIAR WITH THE WEATHER CONDITIONS IN THE AREA.

- COUNTER - 18" DEEP PAINTED GALVANIZED STEEL MOUNTED AT SILL.
- PAINTED STORAGE DRAWER.
- DOOR - 36" WIDE SLIDING STEEL WITH WEATHER-STRIPPING, BALL BEARING HANGERS, HEAVY DUTY TRACK, SAFETY GLAZING, HOOK BOLT LOCK AND HARDWARE.
- 2" DIAMETER HOLE IN COUNTER FOR DROP CORDS.
- DUPLEX OUTLET MOUNTED BELOW COUNTER.
- INTERIOR LIGHT - CODE COMPLIANT LIGHT FIXTURE.
- WALL SWITCH FOR INTERIOR LIGHT.
- HEATER - WALL MOUNTED WITH INTEGRAL THERMOSTAT CONTROL.
- CIRCUIT BREAKER PANEL - 12 SPACE, 120/240V, 1 Ø-3 WIRE WITH GROUND BAR, 100 AMP MAIN BREAKER, AND ALL BRANCH BREAKERS FOR FACTORY INSTALLED DEVICES PROVIDED.
- OPTIONAL REAR COUNTER.
- OPTIONAL HEATER.

NOTE: PAR-KUT BOOTHS ARE OF SINGLE UNIT WELDED STEEL CONSTRUCTION, FACTORY ASSEMBLED AND DELIVERED SET UP. FAILURE TO SECURELY ANCHOR BOOTH MAY RESULT IN OVERTURNING OF UNIT AND SERIOUS INJURY TO OCCUPANT.

- GLAZING - TEMPERED SAFETY GLAZING SET IN PAINTED STEEL EXTERIOR FRAME WITH REMOVABLE INTERIOR ALUMINUM GLAZING STOPS.
- PAINT - FINISH SHALL BE SINGLE COLOR OF CHOICE, IMRON POLYURETHANE HIGH GLOSS INDUSTRIAL COATING. SHALL BE APPLIED TO ALL EXPOSED METAL SURFACES. THIS EXCLUDES ROOF SURFACE, AND ANY STAINLESS STEEL COMPONENTS (IF USED).
- ELECTRICAL - ALL WIRING BY PAR-KUT TO BE #12(MIN) STRANDED COPPER, THHN ENCLOSED IN 1/2"(MIN) E.M.T. PER NATIONAL ELECTRIC CODE. ALL ELECTRICAL EQUIPMENT WILL BE LISTED BY U.L. OR EQUIVALENT RECOGNIZED NATIONAL TESTING LABORATORY. ALL WIRING TO TERMINATE AT C.B. PANEL. ALL CIRCUITS HAVE GREEN GROUND WIRE.
- BOOTH WILL HAVE A 3" CANOPY OVERHANG ON ALL SIDES.
- LIFTING RING(S) ARE PROVIDED ON ROOF.
- NO ON SITE WORK BY PAR-KUT.
- ACTUAL LOCATION OF ELECTRICAL DEVICES MAY VARY DUE TO INSTALLATION CONSTRAINTS, SHIPPING RESTRICTIONS, OR FOR PROPER PLACEMENT TO SATISFY APPLICABLE CODES.

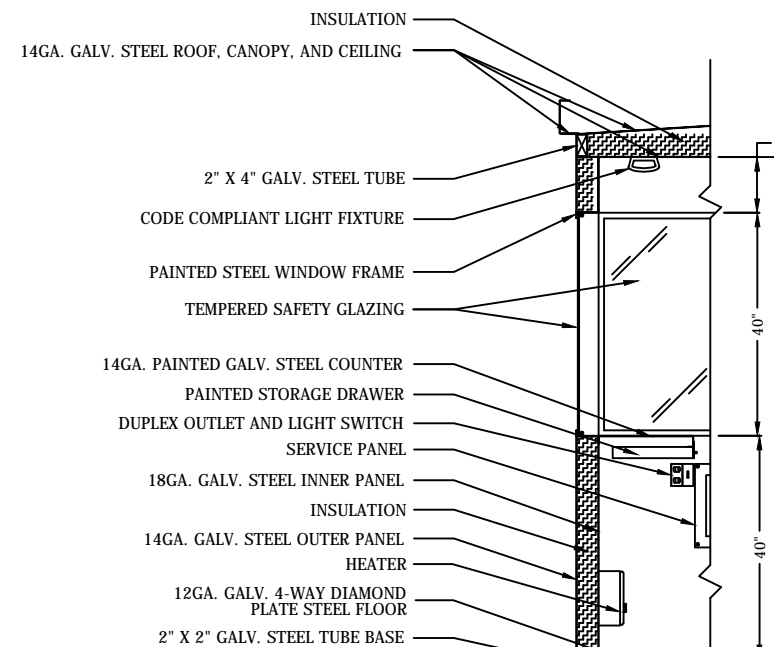

S1 SECTION
NO SCALE

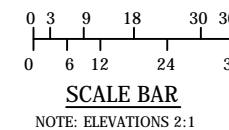

SCALE BAR
NOTE: ELEVATIONS 2:1

NOTE: THIS PRINT AND DESIGN ARE THE PROPERTY OF PAR-KUT INTERNATIONAL, INC. IT MUST NOT BE REPRODUCED IN ANY MANNER, NOR SHALL IT BE SUBMITTED TO OUTSIDE PARTIES FOR EXAMINATION WITHOUT OUR CONSENT. IT SHALL BE USED ONLY AS A MEANS OF REFERENCE TO WORK DESIGNED AND FURNISHED BY PAR-KUT. PAR-KUT RESERVES THE RIGHT TO MAKE CHANGES TO DESIGN FOR ENGINEERING PURPOSES WITHOUT NOTICE. REVISIONS MAY NOT BE NOTED.

PAR-KUT INTERNATIONAL, INC.
40961 Production Drive
Harrison Twp, Mich.
48045-1351
PH. (586) 468-2947
www.parkut.com



DWG# PK107 SHEET A-1

STANDARD 7' X 10' BOOTH
MODEL 107

GENERAL NOTES	
BOOTH PAINT COLOR:	
GLAZING TINT COLOR:	
(PLEASE SPECIFY COLORS)	
OVERALL SHIPPING DIMENSIONS:	7'-6" W X 10'-6" L X 8'-6" H
ESTIMATED WEIGHT:	3,700 LBS.

SCALE	DRAWN BY	REVISED
NTS	DPH	7-27-2017
DATE	SIZE	QTY
12-1-2017	7' X 10'	
CHK'D BY:	SALES REPRESENTATIVE	
RAN		